

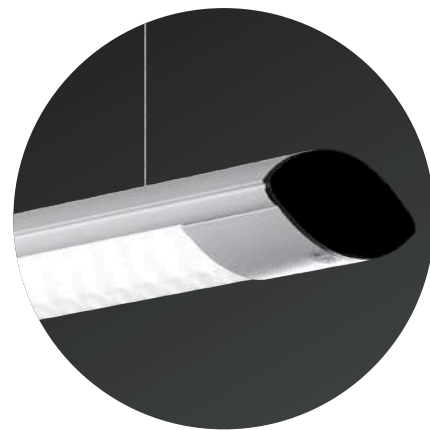

Lisse Lumi LED

Artefacto de aplicar o suspender extra chato.
Accesorios: para montaje en línea y rotulas para armar figuras de 2 y 3 bocas. Cuerpo: de extrusión de aluminio, tratado con pintura electrostática en polvo. Reflector aluminio de alta pureza. Difusor: Louver inyectado / cobertor de policarbonato estriado. Iluminante: LED indular de alto rendimiento (100 lm/W). Vida útil certificada: 51000Hs (LM80/85°C). Disponible para tubo LED y tubo fluorescente.





Lisse Lumi Louver LED

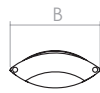

Lisse Lumi Poli LED

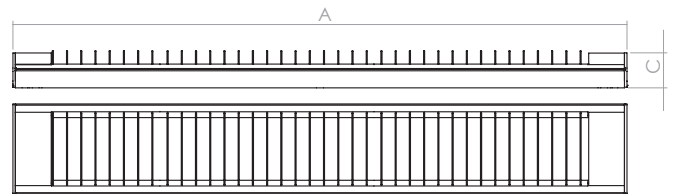

	A	B	C
Lisse Lumi Louver 20/40W	850	124	46
Lisse Lumi Louver 30/60W	1200	124	46

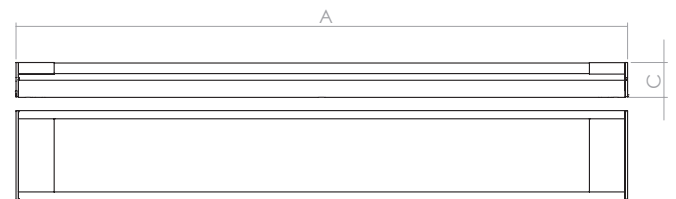
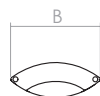

	A	B	C
Lisse Lumi Poli 20/40W	850	124	46
Lisse Lumi Poli 30/60W	1200	124	46

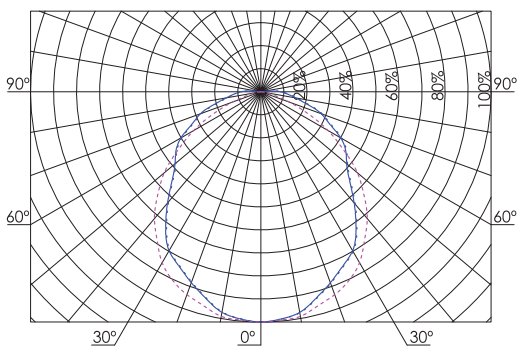

LISSE LUMI LED $I_{max} = 349,16 \text{ cd/klm}$

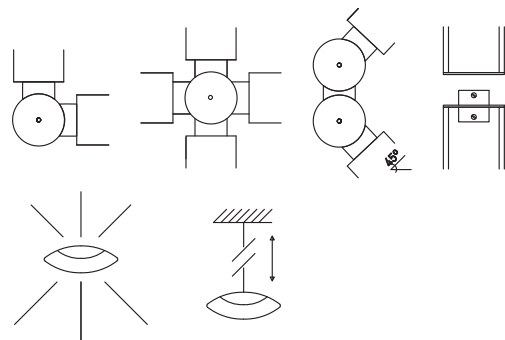
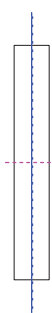

Accesorios y características.



LED Indular

POTENCIA W	FLUJO lm	°K	CRI	VIDA ÚTIL	lm/W
60	6180	3000/5000	80%	50000hs	100
40	4120	3000/5000	80%	50000hs	100
30	3090	3000/5000	80%	50000hs	100
20	2060	3000/5000	80%	50000hs	100